

MRS[®]
Motorized Rod System



FOREST
DRAPERY HARDWARE

WEAR-RESISTANT PULLEY HOUSING



For a low-wear operation the pulley housing has been equipped with high-quality ball bearings.

REINFORCED TRANSPORT BELT



The Kevlar reinforcement of the transport belt ensures a low noise operation, which provides also for a long life.

MOTOR



Three types of motors are available:
230V FMS with 45 or 60 Watt
230V IMS with 45 Watt and build-in receiver
24V Forest Shuttle with touch impulse system

REMOTE CONTROL



Easy opening and closing with the hand-held remote control.

COMPLETELY CLOSED CURTAINS



The overlap carrier guarantees a complete closing of the curtains.

EASY-RUNNING RETURN PULLEY



The special plastic of the return pulley's plain bearing ensures an easy running of the toothed belt.







SELECT YOUR INDIVIDUAL FINIAL



Our large range of decorative finials offers you a great variety of design options. But it is also possible to use without a finial.

HIGH-GRADE ALUMINIUM

We supply the special \varnothing 28-mm rods with the following surfaces:

-  Inox
-  Matt black
-  Polished chrome
-  Bronze
-  Antique Bronze
-  Gold

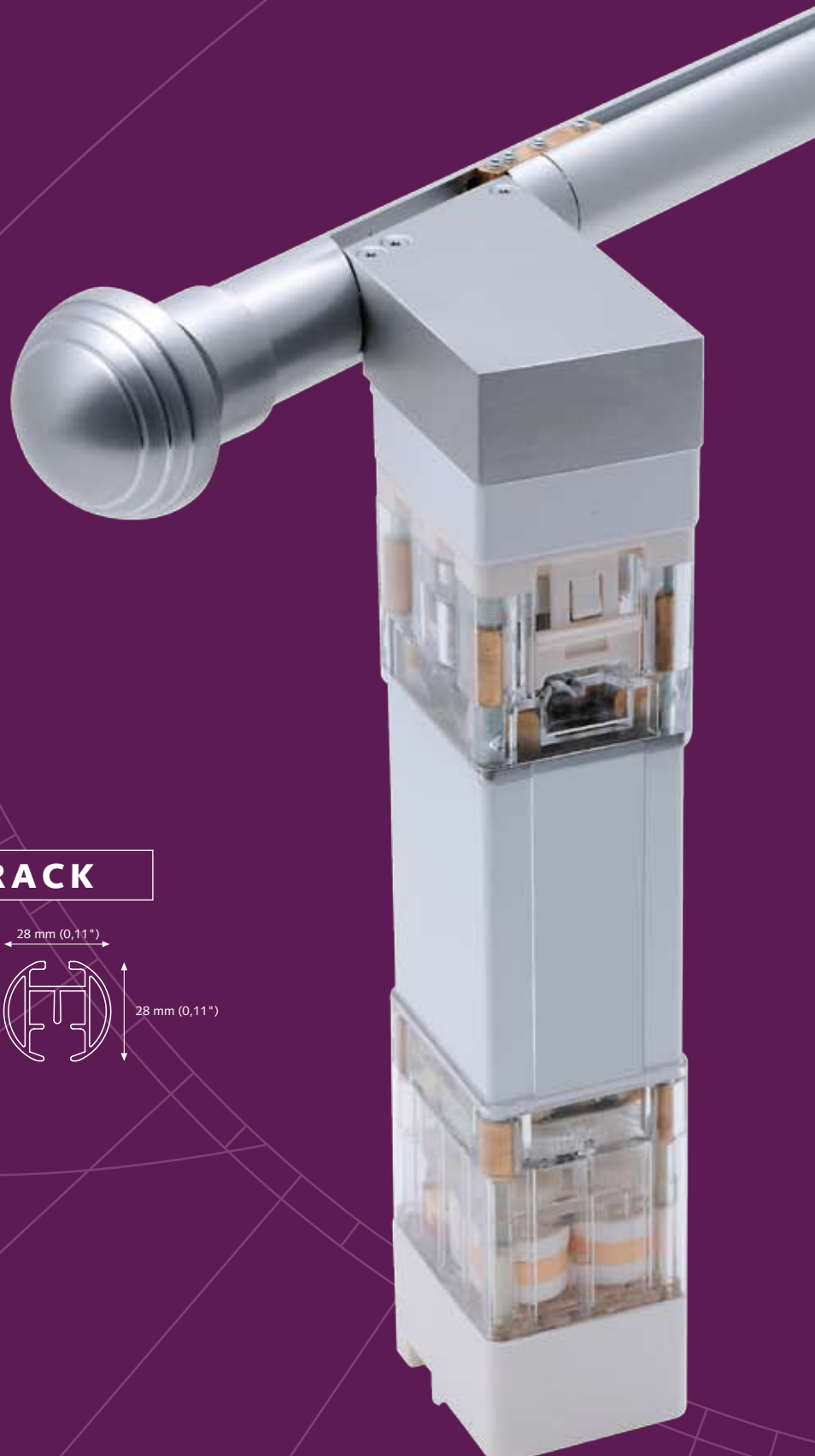

SPECIFICATIONS TRACK

- Weight 480 gr / mtr
- Aluminium Extrusion
- Dimension 28 mm

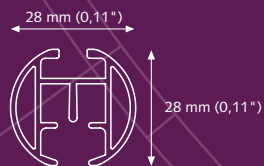

COLOUR CODES ARE AS FOLLOWS:

01 White 02 Gold 04 Bronze 06 Black 07 Chrome 03/08 Inox 09 Antique Bronze

MRS FINIAL GEO-CONE WITH GROOVESColour: black 5716106000
1/box**MRS ENDCAP PEROSA**Colours: 07, 08 57161..300
nickel/chrome
chrome/nickel 5716110000
5716110100**MRS FINIAL ROUND WITH GROOVES**Colour: black 5716106100
1/box**MRS ENDCAP BOLOGNA**Colours: 07, 08 57161..400
nickel/chrome
chrome/nickel 5716110200
5716110300**MRS FINIAL CONE WITH GROOVES**Colour: black 5716106200
1/box**MRS ENDCAP PESCARA**Colours: 07, 08 57161..500
nickel/chrome
chrome/nickel 5716110400
5716110500**MRS FINIAL HALF ROUND WITH GROOVES**Colour: black 5716106300
1/box**MRS ENDCAP MESSINA**Colours: 07, 08 57161..600
nickel/chrome
chrome/nickel 5716110600
5716110700**MRS FINIAL ELLIPS WITH GROOVES**Colour: black 5716106400
1/box**MRS FINIAL CYLINDER SWAROVSKI**GOLD CRISTAL
chrome 5716111300
nickel 5716111400
black 5716111500**MRS ENDCAP RIVA**

Colours 07, 08 57161..000

MRS FINIAL CYLINDER SWAROVSKIRED CRISTAL
chrome 5716111600
nickel 5716111700
black 5716111800**MRS ENDCAP IMPERIA**

Colours: 07, 08 57161..100

MRS FINIAL CYLINDER SWAROVSKIBLACK CRISTAL
chrome 5716111000
nickel 5716111100
black 5716111200**ENDCAP ALLASIO**

Colours: 07, 08 57161..200

MRS FINIAL ROUNDMADE OF CRISTALYZED SWAROVSKI 5716111600
Only in combination with
MRS Fitting for Round Finial.

MRS FITTING FOR ROUND FINIAL

Colours: 06, 07, 08 57162..000



CRS WALL BRACKET

Length: 12 cm (4.72") 582012.28
 Colours: 02, 03, 09 2/box



CRS FINIAL

Ø 28 mm (1,1") 58161.028
 Colours: 02, 03, 09 10/box



CRS WALL BRACKET

Length: 16 cm (6.29") 582016.28
 Colours: 02, 03, 09 2/box



MRS MOTOR PULLEY LEFT

Colours: 02, 03, 04, 06, 07, 08, 09 57301..000
 1/box



MRS WALL BRACKET EXTENSION

Length: 4 cm. 57151..040
 Colours: 06, 07 2/box



MRS MOTOR PULLEY RIGHT

Colours: 02, 03, 04, 06, 07, 08, 09 57302..000
 1/box



MRS WALL BRACKET EXTENSION

Length: 8 cm. 57151..080
 Colours: 06, 07 2/box



MRS RETURN PULLEY LEFT

Colours: 2, 4, 6, 7, 8, 9 573011.000
 1/box



CRS WALL BRACKET EXTENSION

Length: 8 cm. 58151..020
 Colours: 02, 03, 09 2/box

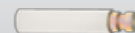

MRS RETURN PULLEY RIGHT

Colours: 2, 4, 6, 7, 8, 9 57200..120
 1/box



MRS CEILING BRACKET

Length: 1,5 cm 57184..050
 Colours: 06, 07 4/box



MRS WALL BRACKET

Length: 12 cm (4.72") 57200..120
 Colours: 06, 07 2/box



MRS CEILING BRACKET

Length: 5 cm 57180..050
 Colours: 06, 07 4/box



COLOUR CODES ARE AS FOLLOWS:

01 White 02 Gold 04 Bronze 06 Black 07 Chrome 03/08 Inox 09 Antique Bronze

MRS CEILING EXTENSION

Length: 4 cm 571840.040
2/box
Colours: 6, 7

**MRS TRACK/PULLEY CONNECTOR**

WIDE 5718402000
10/box

**MRS CEILING EXTENSION**

Length: 8 cm 571840.080
2/box
Colours: 6, 7

**PULLEY SET CORDED MRS WITH CHAIN**

1.75 Mtr drop 5770000350
2.00 Mtr drop 5770000400
2.50 Mtr drop 5770000500
1/box

**CEILING SUSPENSION BRACKET**

10 cm (4") bracket 58180.2028
2/box
Colours: 02, 03, 09

**MRS TRACK**

Gold 5.80 mtr 5701282580
Bronze 5.80 mtr 5701284580
Black 5 mtr 5701286520
Chrome 5 mtr 5701287525
Antique Bronze 5.80 mtr 5701289580
Inox 5.80 mtr 5701283580

**CEILING SUSPENSION BRACKET**

4 cm (1,6") bracket 58181.2000
2/box
Colours: 2, 3, 9

**MRS INSIDE WALL BRACKET**

Colours: 6, 7 572228.000
2/box

**AS CARRIER**

Colours: 01, 03, 06 25101..000
250/box

**INSIDE WALL BRACKET**

Colours: 02, 03, 09 58171.028
2/box

**MASTER CARRIER UNDERLAP**

Colours: 01, 03, 06 30156..000
15/box

**MRS TRACK/PULLEY CONNECTOR**

SLIM 5718401000
10/box

**MASTER CARRIER OVERLAP**

Colours: 01, 03, 06 30157..000
15/box



CURTAIN MOTORS AND CONTROLS

For more information about the curtain motors and controls see our FMS and Forest Shuttle brochures.

