

# FOREST

DRAPERY HARDWARE



**CRS**<sup>®</sup>  
*Channel Rod System*

# CRS<sup>®</sup> Channel Rod System

## Product Information

- Elegant and trendy channel rod system.
- Easy and quick assembly.
- Rod available in 20 mm (0,8") and 28 mm (1,1") thickness.
- Bendable, both with an inside and outside corner with a 20 cm (7,9") (20 mm (0,8") rod) or 40 cm (15,7") radius (28 mm (1,1") rod).
- Colours: white, bronze, antique bronze, stainless steel and gold.
- The brackets and end caps are available in white, stainless steel and gold.
- Length: 5,80 m (19').
- Rail quality: aluminium, chromated, powder coated.
- Carriers are anti-friction treated.

## Applications

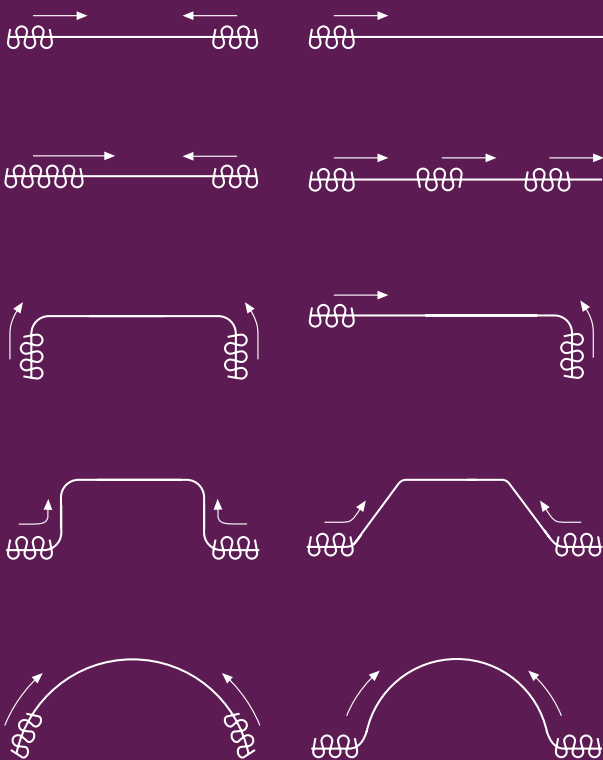

## Rail Specifications

- Shown actual size 1:1
- Aluminium Extrusion
- Weight 20 mm (0,8"): 320 grammes per meter
- Weight 28 mm (1,1"): 460 grammes per meter
- Dimensions: 20 mm (0,8") and 28 mm (1,1")

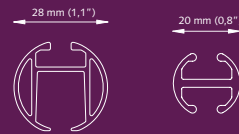

## For use in

Domestic and / or project market, or at any location where a high quality, elegant and manually operated channel rod system is desired.

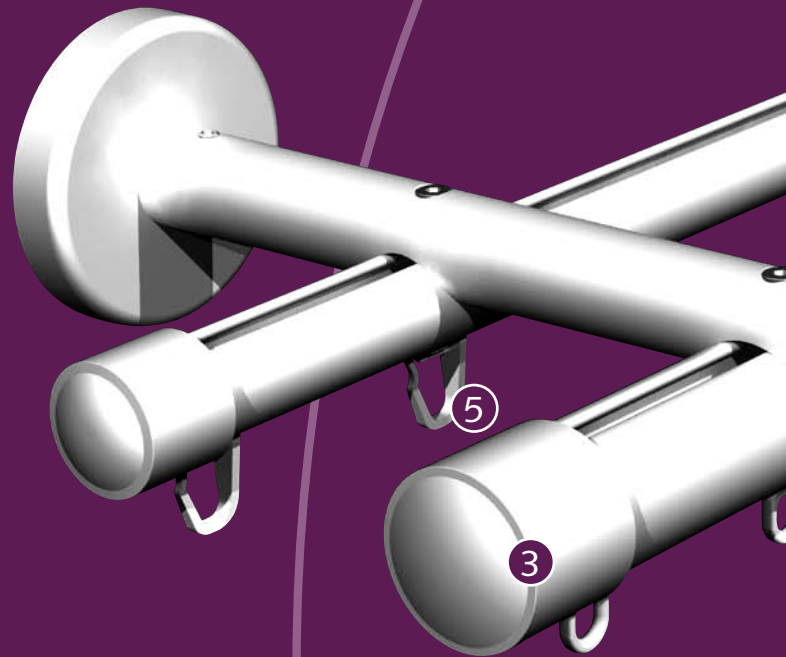

## Bending / Curving

The 20 mm (0,8") rod can be curved and reverse curved using a radius of 10 cm (4"); The 28 mm (1,1") rod can be curved and reverse curved by using a radius of 20 cm (8").

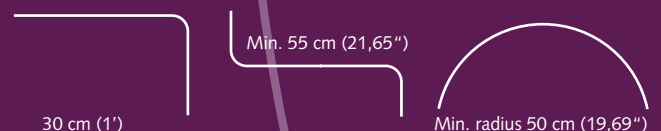

## Mounting Brackets

- ① CRS Rod 20 mm (0,8")
- ② CRS Rod 28 mm (1,1")
- ③ CRS End Cap
- ④ CRS Carrier
- ⑤ KS Shirrtape Carrier
- ⑥ CRS Wall Bracket Double

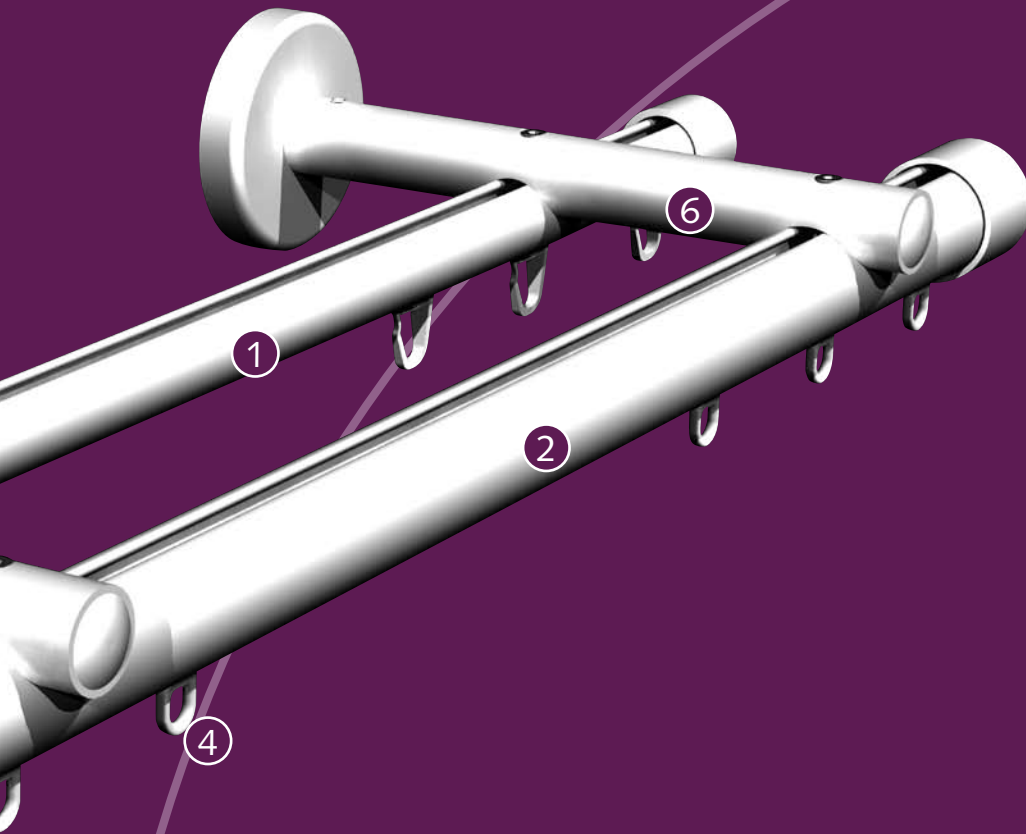

### CRS Ceiling Support

5 cm (2") or 10 cm (4").

20 mm (0,8")/ 28 mm (1,1").

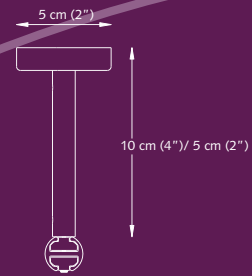

### CRS Wall Support, Single

8 cm (3,1") Ø 20 (0,8")

or 28 mm (1,1").

12 cm (4,7") Ø 20 (0,8")

or 28 mm (1,1").

16 cm (6,3") Ø 20 (0,8")

or 28 mm (1,1").

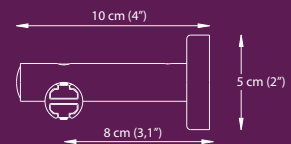

### CRS Wall Support, Double

16 cm (6,3") Ø 20 mm (0,8")

16 cm (6,3") Ø 28 mm (1,1")

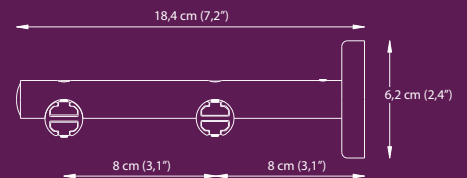

### CRS Wall Support, Double

16 cm (6,3") Ø 20/28 mm (0,8/1,1")

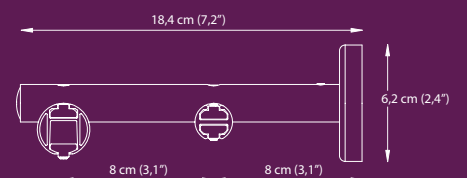

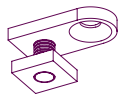
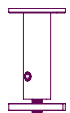
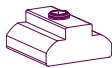
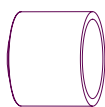
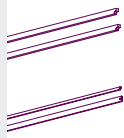
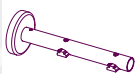
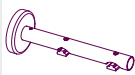
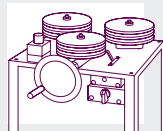
**Colours available****1 White, 2 Gold, 3 Inox, 4 Bronze,  
9 Antique Bronze**The inox coloured parts are used for both  
the bronze and the inox coloured rod types**CRS Channel Rod**Extruded aluminium, chromated,  
powder coated, 5,80 mtr  
Ø 20 mm (0,8") (46.4 mtr/bundle) 580120.580  
Ø 28 mm (1,1") (23.2 mtr/bundle) 580128.580**CRS Ceiling Bracket with hole**white 5818003101  
silver 5818003103  
100/box**CRS Ceiling Suspension bracket,  
Ø 20/28 mm (0,8/1,1")**10 cm (4") bracket  
Colours: 01, 02, 03, 09 58180.2028  
2/box**CRS Carrier**UV-Proof, synthetic material 5810001000  
10 Carriers on a break away strip 500/box  
Colour: 01**CRS Ceiling Suspension bracket,  
Ø 20/28 mm (0,8/1,1")**4 cm (1,6") bracket  
Colours: 01, 02, 03, 09 58181.2000  
2/box**CRS Metal End-stop with Screw**For fixing one carrier as an end stop  
Ø 20 mm (0,8") 5816101000  
Ø 28 mm (1,1") 5816101001  
100/box**CRS Inside Wall Bracket**For the purpose of installing the rod inside  
a window frame. Colours: 01, 02, 03, 09 2/box  
Ø 20 mm (0,8") 58171.020  
Ø 28 mm (1,1") 58171.028**CRS Finial**Ø 20 mm (0,8") 58161.020  
Ø 28 mm (1,1") 58161.028  
10/box  
Colours: 01, 02, 03, 09**Compact Bending House**For 20 mm (0,8") CRS 1050000000  
1/each**CRS Bending Wheel** Ø 20 cm (8") 5860000020  
For 20 mm (0,8") CRS incl. strips 1/each**CRS Wall Bracket, single 8 cm (3,15")**For Ø 20 mm rod (0,8") 582008.20  
For Ø 28 mm rod (1,1") 582008.28  
2/box  
Colours: 01, 02, 03, 09**Contract Bending Tool**For 20 and 28 mm (1,1") CRS 2550000000  
1/each**CRS Contract Bending  
Wheel all-in** Ø 20 cm (8") 5860200020  
For 20 mm (0,8") CRS, incl. strips 1/each**CRS Wall Bracket, single 12 cm (4,72")**For Ø 20 mm rod (0,8") 582012.20  
For Ø 28 mm rod (1,1") 582012.28  
2/box  
Colours: 01, 02, 03, 09**CRS Bending Wheel** 5860000028  
Ø 40 cm (16") 1/each  
For 28 mm (1,1") CRS, incl. strips**CRS Wall Bracket, single 16 cm (6,29")**For Ø 20 mm rod (0,8") 582016.20  
For Ø 28 mm rod (1,1") 582016.28  
2/box  
Colours: 01, 02, 03, 09**CRS Bending Strips**Ø 20 mm (0,8"), 60 cm (23,6") 5860100020  
Ø 28 mm (1,1"), 60 cm (23,6") 5860100028  
1/each  
Ø 20 mm (0,8"), 7 m (23') 5860700020  
Ø 28 mm (1,1"), 7 m (23') 5860700028  
1/each**CRS Wall Bracket, double 16 cm (6,29")**Ø 20 mm (0,8") 582216.20  
Ø 28 mm (1,1") 582216.28  
2/box  
Colours: 01, 02, 03, 09**Bending Stand**Stand for Contract Bending  
tool 28 mm (1,1") 2560700000  
1/each**CRS Wall Bracket, double 16 cm (6,29")**Ø 20/28 mm (0,8/1,1") 5822.2028  
2/box  
Colours: 01, 02, 03, 09**Electric Powered Bender**available in 230 V or 115 V 1060500000  
1/each**Set CRS Bending Wheels** 5860702028  
Ø 20/28 mm (0,8/1,1") 1/set**CRS Extension Piece**Inox 8 cm (3,15") 5815103020  
10/box**Electric Powered Rail Cutter**Rail cutter for all light  
aluminium profiles 1061100000  
1/each**Replacement Blade** 1061200000  
For electric powered rail cutter 1/each**CRS Ceiling Bracket**Ø 20/28 mm (0,8/1,1"),  
aluminium 5818003000  
100/box

Distributor: