

Evans Textile Group Limited Price List Index - April 2006

PRODUCT	ACCESSORIES	HEADING TAPE	BLIND ACCESSORIES	CUSHIONS	UPHOLSTERY	CURTAIN LINING	BLACKOUT	INTERLINING	FLAME RETARDANT	EVAGLIDE TRACKS
Adhesive	28				34					
Austrian/Festoon Tape			20							
Blind Cord			20							
Bolsters				32						
Books	28									
Brackets	26									
Braid					35					
Brassware	18									
Brushed Steel	18									
Buckrams	14/15									
Chrome	18									
Contact Tape		13								
Cord			20							
Cushions				32						
Easy Cover Buttons	26									
Evaglide - Contract Track										48
Evaglide - Contract Corded Track										50
Evaglide - Corded Klick Track										44
Evaglide - Design Track										46
Evaglide - Klick Track System										42
Evaglide - Panel System										52
Evaglide - Ripplefold System										42-50
Eyelet Heading Tape		13								
Flame Retardant Heading Tape		13								
Flame Retardant Heading Tape		12								
Hooks		16								
Interlining Heavy Bump								07		38
Interlining Synthetic/Sarille								07		38
Interlining Shrunk								07		38
Lead Weight Tape		16								
Lead Penny Weights		26								
Lining/Interlining combined 2-fold								08		38
Linings - Blackout				35		06				39
Linings - Coloured Sateen						02				36
Linings - Deluxe Sateen						02				36
Linings - Poly/Cotton						03				37
Linings - Premium Sateen						02				
Linings - Blackout Ready Made							06			
Linings - Poly/Cotton Ready Made						03				
Linings - Thermal							06			
Mattress Protectors	33									
Multi Woven Pockets		11								
Muslin						08				
Net Pleat Tape/Translucent		13								
Order Forms for the Tracks			25							54/55
Perfect Pleat Heading Tape		13								
Pencil Pleat - Woven Pockets		11								
Pencil Pleat - Corded Pockets		12								
Pillows, Duvets				33						
Pinch Pleat - Woven Pockets		11								
Pins		27								
Piping Cord		29								
Platform Cloth					34					
Polythene Tubing		28								
Rings-D, Hollow and Split Rings		19	20							
Rods			23							
Roman Blind Systems			22-24							
Roman Blind Tape			23							
Schedule 3 Interliner				34						
Scissors		27								
Sewing Threads		31								
Shower Proof Curtaining										39
Silicone		28		34						
Snapper Tape		12								
Suede, Blackout				35		06				40
Suede for Drapes				35						
Staples				34						
Table Clamps		27								
Tape Measures		27								
Triple Pleat - Corded pockets			12							
Upholstery Sundries				34				09		
Velcro		16	21							
Voile										37
Wadding		33								
Web Tapes				30						
Wire/Hooks/Eyes		20								
Wooden Acorns			21							
Workroom Tapes			12							
Zips and Sliders		17								

Evaglide Curtain Engineering

Evaglide tracks are manufactured from powder-coated aluminium to ensure low maintenance and performance longevity; the systems can comfortably support heavy weight drapes such as full height interlined curtains.

Simple installation and maintenance make it ideal for hotels, motels, offices, schools, hospitals and private homes. The Evaglide tracks are reverse bendable around any bay window without creasing. Available in hand-drawn or corded versions, all of which are performance guaranteed.

If required we will manufacture the track and deliver to site for your convenience. To obtain a quote, please photocopy the ordering sheets contained within the price list.

Alternatively you can save costs by assembling your own tracks. Consider the savings by comparing the components and tracks price in the starter pack guide.

The Ripplefold design option allows you to manufacture a curtain which arrives on site ready to be hung with the minimal of dressing to produce the perfect pleat. Ripplefold can be used with any of the Evaglide profiles.

An Evaglide panel system is a contemporary solution for floor to ceiling windows and patio doors. For your convenience we can offer the full bespoke manufacturing service including the laminating your fabrics.

Evans Textile Wholesale stock Rufflette products for distribution. We offer single items per outer. If you require branded Rufflette products please request a current Rufflette price list and deduct 35% off the list price ex VAT.

EVANS TEXTILE
SALES LIMITED

Telephone: 0161 274 4147
Facsimile: 0161 274 4070
email: info@evans-textiles.com

EVANS TEXTILE
- WHOLESALE LIMITED -

Telephone: 0208 590 8666
Facsimile: 0208 590 8164
email: info@evans-textiles.com

EVANS TEXTILE
SALES LIMITED

www.evans-textiles.com

Tel. 0161 274 4147

Fax. 0161 274 4070

KS Klick System - Component Price List

PRODUCT CODE	PRODUCT DESCRIPTION	PER BOX	UNIT PRICE
780000A	KS 6mts Aluminium Track White	20 x 6mts	
780079A	KS 5mts Aluminium Track Silver	20 x 5mts	
780001	KS/CKS Offset Carrier White	500	
780004	KS Klick Endstop with Cap White	100	
780006	KS Twist End Stop White	100	
780002	KS Stop Carrier White	250	
780084	Klick On Splice/Joiner	50	
780081	KS Pelmet 90 Degree Return	50	

KS Klick System - Starter Pack

PRODUCT CODE	PRODUCT DESCRIPTION	QUANTITY	PRICE
780000A	KS 6mts Aluminium Track White	60mts	
780010	KS Smart Klick Wall Bracket 35mm White	50	
780008	KS Smart Klick Ceiling Bracket	50	
780001	KS / CKS Offset Carrier White	1000	
780004	KS Klick Endstop with Cap White	60	
	KS Klick Track Systems Starter Pack On Average This Starter Kit Makes 30 Tracks at 2 Metres.	Total Cost Approximate Cost per Track	

KS Klick System - Made to Measure Prices

TRACK TYPE TRACK WIDTH	790701 KS HAND-DRAWN	790702 KS HAND-DRAWN RIPPLEFOLD
1.0mts		
1.5mts		
2.0mts		
2.5mts		
3.0mts		

Note: All quoted prices include all the relevant components and, for the purposes of this price guide, have been calculated using the ceiling fix brackets. Wall fix brackets and batons quoted for separately. All tracks quoted are finished in white. For Silver option on the tracks and fittings please request specific quotes.

Bracket Options

PRODUCT CODE	PRODUCT DESCRIPTION	PER BOX	UNIT PRICE
780007	Ceiling Bracket White	100	
780008	Smart Klick Ceiling Bracket	100	
780009	Smart Klick Double Ceiling Bracket White	50	
780010	Smart Klick Wall Bracket 35mm White	50	
780011	Smart Klick Wall Bracket 60mm White	50	
780012	Smart Klick Aluminium Bracket 75mm single	20	
780013	Smart Klick Aluminium Bracket 100mm single	20	
780014	Smart Klick Aluminium Bracket 150mm double	15	
781022	Smart Klick Adjustable Bracket white	25	

Note: Whilst it is our intention to maintain these prices for as long as possible, they are subject to fluctuation due to raw material increases beyond our control.

PRODUCT INFORMATION

- Highly efficient hand drawn system for all types of medium weight draperies.
- Quick installation with "Smart Klick" brackets for wall and ceiling applications.



- Bendable; it can be curved and reverse curved using a 10cm radius or continuously curved.
- Suitable for special window decoration as circular, arch and triangle window models.
- Heavy duty klickable carriers - UV protected - for smooth and easy traversing. Offset shape for straight hanging pleats.
- Can also be used for ripplefold.
- Maximum fabric weight: 4 kg per metre.
- Track finish: chromated powder coating with a factory applied patented dry lubricant.
- Limited lifetime warranty.

BENDING/CURVING

The track can be curved and reverse curved using a 10cm radius. Continuous curving can easily be done using the continuous curver. Also the possibility of curving for special windows, such as arches, bows and circles.

Evans offer a made to order service.



Bending instructions available on request

PROFILE

Weight: 150 grams per metre
Dimensions: 14mm x 20mm

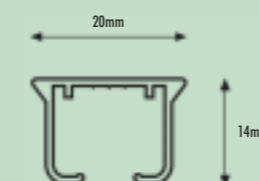

FOR USE IN

Hotels - offices - schools - healthcare - residences - boats - homes - planes or anywhere an efficient hand drawn system is required.

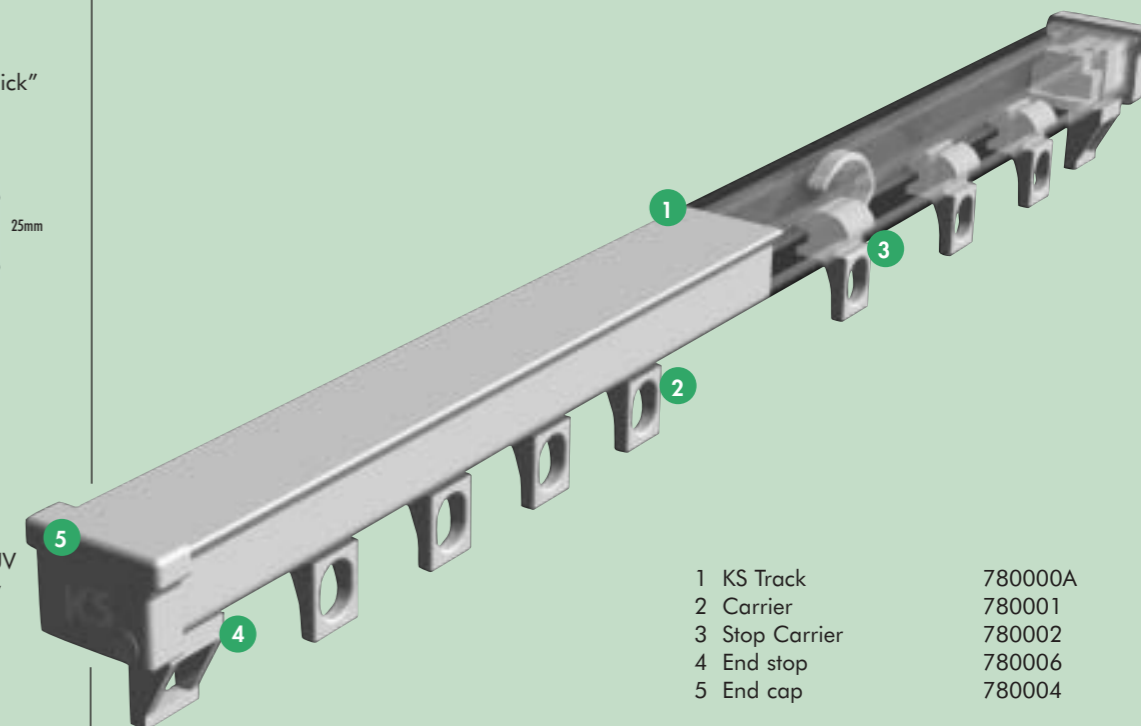

- | | |
|----------------|---------|
| 1 KS Track | 780000A |
| 2 Carrier | 780001 |
| 3 Stop Carrier | 780002 |
| 4 End stop | 780006 |
| 5 End cap | 780004 |

APPLICATIONS

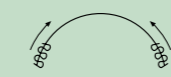
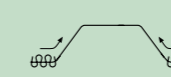
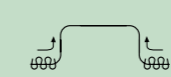
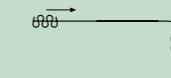
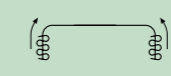
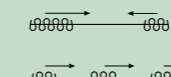
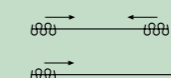

MOUNTING BRACKETS

Ceiling Bracket 780008

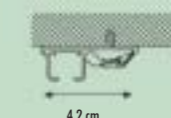

Wall Bracket 780010

3.5 cm
6 cm



A) Min. 10cm



A) Min. 15cm



Wall bracket aluminium single

780012 A) 7.5cm : B) 6.3cm
780013 A) 10cm : B) 8.8cm

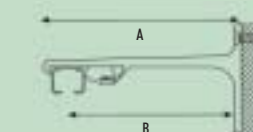

Wall bracket aluminium double

780014 A) 15cm : B) 9.2cm C) 4.5cm
A) 20cm : B) 9.2cm C) 9.5cm

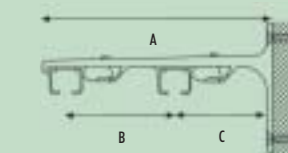

Wall bracket aluminium triple

25cm

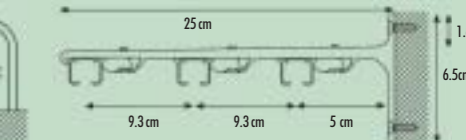

- Adjustable bracket available **781022**
- Two brackets at each end 60cm apart and up to 95cm over remainder of track depending on weight of treatment.

CKS Corded Klick System - Component Price List

PRODUCT CODE	PRODUCT DESCRIPTION	PER BOX	UNIT PRICE
780019A	CKS 6mts Aluminium Track White	20 x 6mts	
780001	KS / CKS Off Set Carrier White	500	
780024	CKS Reversible Pulley White	25	
780020	CKS Reversible Overlap Carrier White	25	
780021	CKS Reversible Underlap Carrier White	25	
780022	CKS Cord Connector White	100	
780023	CKS Half Cord Connector White	100	
780025A	CKS/CCS 250mts Traverse Cord	250mts	
780098	CKS Reversible Centre Pulley	20	
780085	CKS Extension Arm For Master Carrier	50	
780041	White Cord Weight	100	
780027	CKS/CCS Metal Tension Pulley - White	25	
780084	Click On Splice/Joiner	50	

CKS Corded Klick System - Starter Pack

PRODUCT CODE	PRODUCT DESCRIPTION	QUANTITY	PRICE
780019A	CKS 6mts Aluminium Track White	60mts	
780001	KS / CKS Off Set Carrier White	1000	
780024	CKS Reversible Pulley White	30	
780020	CKS Reversible Overlap Carrier White	15	
780021	CKS Reversible Underlap Carrier White	15	
780022	CKS Cord Connector White	30	
780023	CKS Half Cord Connector White	15	
780025A	CKS/CCS 250mts Traverse Cord	250mts	
780012	Smart Klick Aluminium Bracket 75mm Single	50	
780008	Smart Klick Ceiling Bracket	50	
	CKS Corded Klick Track Systems Starter Pack On Average This Starter Kit Makes 15 Tracks at 2 Metres.	Total Cost Approximate Cost per Track	

CKS Corded Klick System - Made to Measure Prices

TRACK TYPE TRACK WIDTH	790801 CKS CORDED TRACK	790602 CKS CORDED TRACK WITH RIPPLEFOLD SYSTEM
1.0mts		
1.5mts		
2.0mts		
2.5mts		
3.0mts		

Note: All quoted prices include all the relevant components and, for the purposes of this price guide, have been calculated using the ceiling fix brackets. Wall fix brackets, cord weights and tension pulleys quoted for separately. All tracks quoted are finished in white. For Silver option on the tracks and fittings please request specific quotes.

Bracket Options

PRODUCT CODE	PRODUCT DESCRIPTION	PER BOX	UNIT PRICE
780007	Ceiling Bracket White	100	
780008	Smart Klick Ceiling Bracket	100	
780009	Smart Klick Double Ceiling Bracket White	30	
780010	Smart Klick Wall Bracket 35mm White	50	
780011	Smart Klick Wall Bracket 60mm White	50	
780012	Smart Klick Aluminium Bracket 75mm single	20	
780013	Smart Klick Aluminium Bracket 100mm single	20	
780014	Smart Klick Aluminium Bracket 150mm double	15	
781022	Smart Klick Adjustable Bracket White	25	

PRODUCT INFORMATION

- Highly efficient cord traversing system with separate internal cord channels; preventing cord sag and eliminating cord tangle.

- Quick installation with "Smart Klick" brackets for wall and ceiling applications.

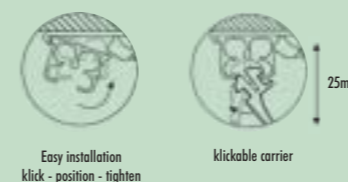

- Bendable; it can be curved and reverse curved by using a 10cm radius or continuous curve.

- Heavy duty klickable carriers - UV protected - for smooth and easy traversing. Offset shape for straight hanging pleats.

- Can also be used for ripplefold.

- Maximum fabric weight: ± 4 kg per metre.

- Track finish: chromated powder coating with a factory applied patented dry lubricant.

- Limited lifetime warranty.

BENDING/CURVING

The track can be curved and reverse curved using a 10cm radius. Continuous curving can easily be done using the continuous curver or the electric powered bender or available by special order from factory



PROFILE

Weight: 202 grams per metre
Aluminium Extrusion 6063 T5.
Dimensions: 14mm x 20mm

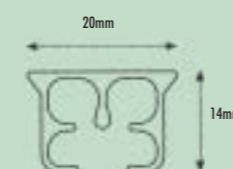

FOR USE IN

Hotels - offices - residences - boats homes - planes or anywhere an efficient cord traversing system is required.

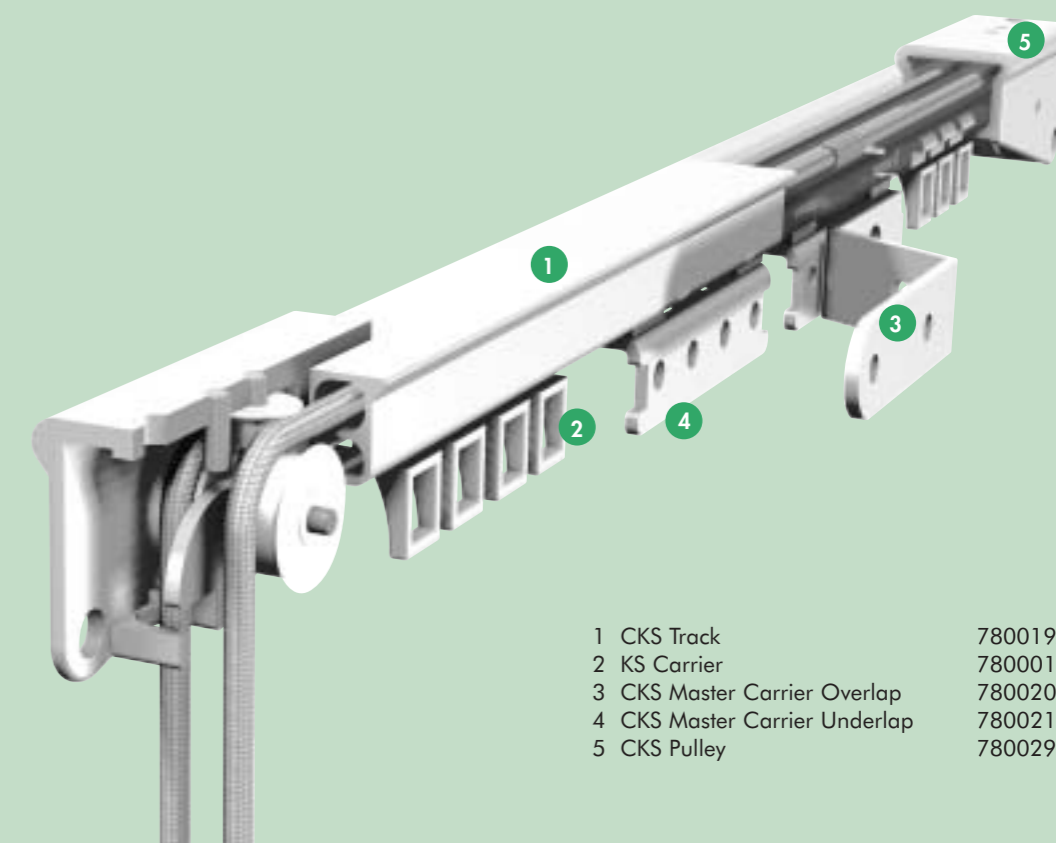

- | | |
|-------------------------------|---------|
| 1 CKS Track | 780019A |
| 2 KS Carrier | 780001 |
| 3 CKS Master Carrier Overlap | 780020 |
| 4 CKS Master Carrier Underlap | 780021 |
| 5 CKS Pulley | 780029 |

APPLICATIONS

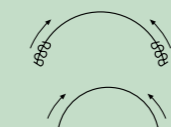
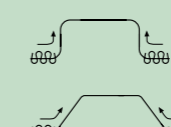
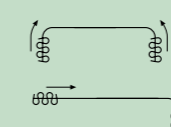
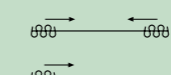

MOUNTING BRACKETS

Ceiling Bracket 780008

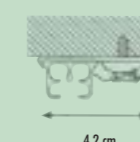

Wall bracket aluminium single
780012 A) 7.5cm : B) 6.3cm
780013 A) 10cm : B) 8.8cm

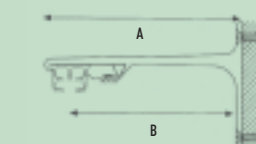

Wall Bracket 780010

3.5 cm
6 cm



Wall bracket aluminium double
780014 A) 15cm : B) 9.2cm C) 4.5cm
A) 20cm : B) 9.2cm C) 9.5cm

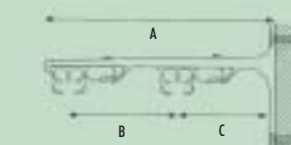

A) Min. 10cm



Wall bracket aluminium triple
25cm

A) Min. 15cm

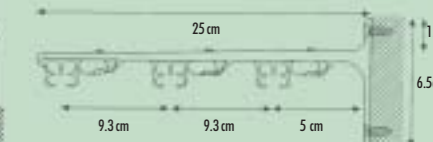
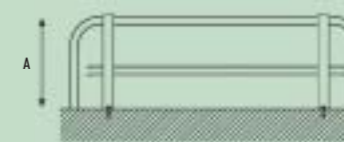

- Adjustable bracket available 781022
- Two brackets at each end 60cm apart and up to 95cm over remainder of track depending on weight of treatment.

DS Design System - Component Price List

PRODUCT CODE	PRODUCT DESCRIPTION	PER BOX	UNIT PRICE
781015A	DS 6mts Aluminium Track White	20 x 6mts	
780089A	DS 6mts Aluminium Track Silver	20 x 6mts	
780001	KS / CKS Offset Carrier White	500	
781016	DS Twist Endstop With Cap White	100	
780002	KS Stop Carrier White	250	
780084	Klick On Splice/Joiner	50	

DS Design System - Starter Pack

PRODUCT CODE	PRODUCT DESCRIPTION	QUANTITY	PRICE
781015A	DS 6mts Aluminium Track White	60mts	
780010	Smart Klick Wall Bracket 35mm White	50	
780008	KS Smart Klick Ceiling Bracket	50	
780001	KS / CKS Offset Carrier White	1000	
781016	DS Endcap White	60	
	DS Design System Track Starter Pack On Average This Starter Kit Makes 30 Tracks at 2 Metres.	Total Cost Approximate Cost	

DS Design System - Made to Measure Prices

TRACK TYPE TRACK WIDTH	790501 DS HAND DRAWN TRACK	790601 DS HAND DRAWN TRACK WITH RIPPLEFOLD SYSTEM
1.0mts		
1.5mts		
2.0mts		
2.5mts		
3.0mts		

Note: All quoted prices include all the relevant components and, for the purposes of this price guide, have been calculated using the ceiling fix brackets. Wall fix brackets and batons quoted for separately. All tracks quoted are finished in white. For Silver option on the tracks and fittings please request specific quotes

Bracket Options

PRODUCT CODE	PRODUCT DESCRIPTION	PER BOX	UNIT PRICE
780007	Ceiling Bracket White	100	
780008	Smart Klick Ceiling Bracket	100	
780009	Smart Klick Double Ceiling Bracket White	30	
780010	Smart Klick Wall Bracket 35mm White	50	
780011	Smart Klick Wall Bracket 60mm White	50	
780012	Smart Klick Aluminium Bracket 75mm single	20	
780013	Smart Klick Aluminium Bracket 100mm single	20	
780014	Smart Klick Aluminium Bracket 150mm double	15	
781022	Smart Klick Adjustable Bracket White	25	

PRODUCT INFORMATION

- Elegant hand drawn system for all types of medium weight draperies.
- Quick installation with "Smart Klick" brackets for wall and ceiling applications.
- Bendable; it can be curved and reverse curved using a 10cm radius.
- Also bendable in different radii for bay windows.
- Same brackets as used with KS system.
- Heavy duty clickable carriers - UV protected - for smooth and easy traversing. Offset shape for straight hanging pleats.
- Can also be used for ripplefold.
- Maximum fabric weight: 4 kg per metre.
- Track finish: chromated powder coating with a factory applied patented dry lubricant.
- Limited lifetime warranty.

BENDING/CURVING

The track can be curved and reverse curved, using a 10cm radius. Curves with a larger radius can be bent with the electric bending tool, or are available on request.

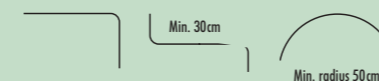

See brochure Bending Instructions for details.

PROFILE

Weight: 170 grams per metre
Aluminium extrusion 6063 T5.
Dimensions: 11mm x 24mm

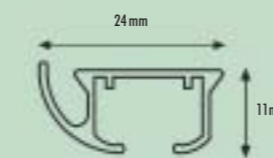

FOR USE IN

Hotels - offices - schools - healthcare - residences - boats - homes - planes or anywhere an elegant efficient hand drawn system is required.

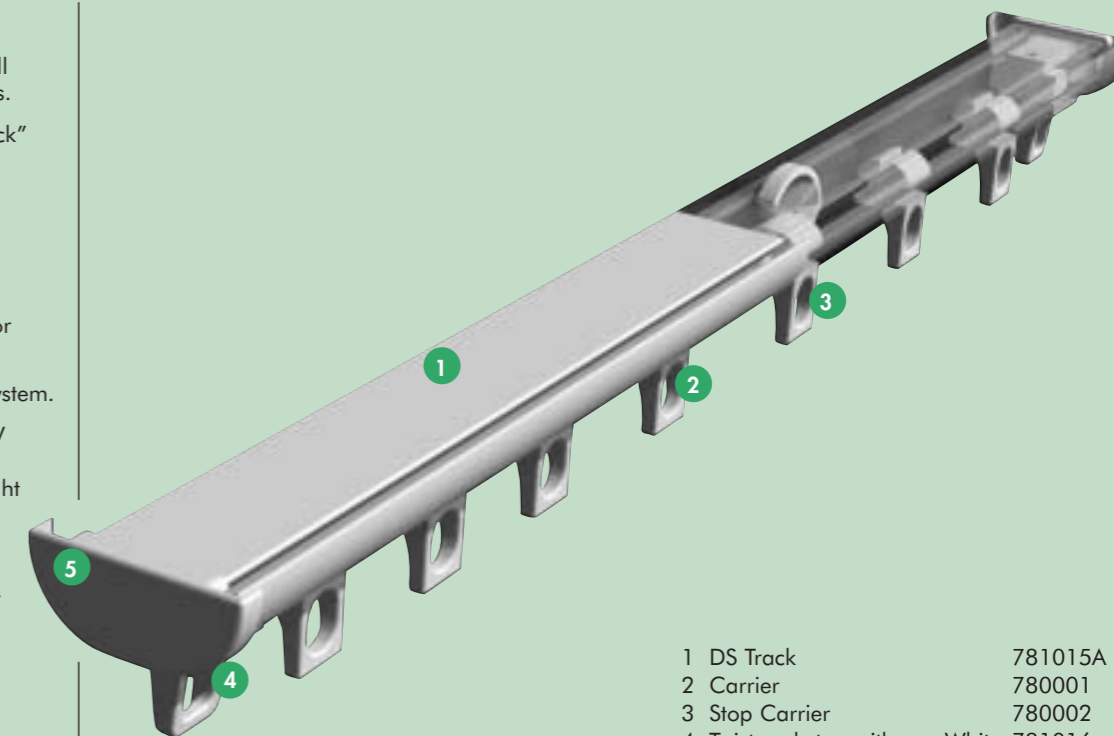

- 1 DS Track 781015A
- 2 Carrier 780001
- 3 Stop Carrier 780002
- 4 Twist end stop with cap White 781016
- 5 Twist end stop with cap White 781016

APPLICATIONS

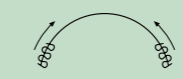
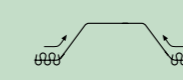
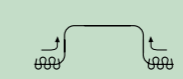
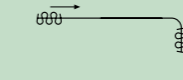
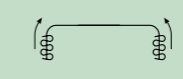
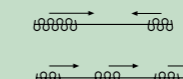
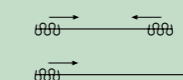

MOUNTING BRACKETS

SK Ceiling Bracket 780008



SK Wall bracket aluminium single 780012 A) 7.5cm : B) 6.3cm 780013 A) 10cm : B) 8.8cm

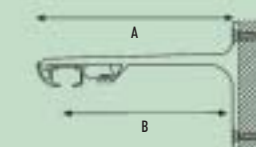

SK Wall Bracket 780010

3.5 cm
6 cm



A) Min. 10cm



A) Min. 15cm



SK Wall bracket aluminium double 780014 A) 15cm : B) 9.2cm C) 4.5cm A) 20cm : B) 9.2cm C) 9.5cm

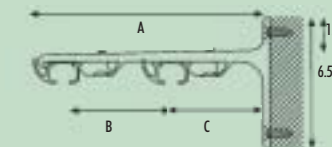

CS Contract System - Component Price List

PRODUCT CODE	PRODUCT DESCRIPTION	PER BOX	UNIT PRICE
780000A	CS 6.1mts Aluminium Track White	20 x 6.1mts	
780073	CS / CCS AS Carrier White	200	
780074	CS Endcap and screw	100	
780075	CS/CCS Economy Slide	500	
780076	CS/CCS Ball Bearing Carrier Slimline	100	
780084	Click On Splice/Joiner	100	

CS Contract System - Starter Pack

PRODUCT CODE	PRODUCT DESCRIPTION	QUANTITY	PRICE
780000A	CS 6.1mts Aluminium Track White	30.5mts	
780073	CS / CCS Carrier White	200	
780074	CS Endcap and screw	30	
780008	Smart Klick Ceiling Bracket	50	
780010	Smart Klick Bracket 35 mm White	50	
	CS Contract System Starter Pack On Average This Starter Kit Makes 15 Tracks at 2 Metres.	Total Cost Approximate Cost per Track	

CS Contract System - Made to Measure Prices

TRACK TYPE TRACK WIDTH	790901 CS HAND DRAWN TRACK	790902 CS HAND DRAWN TRACK WITH RIPPLEFOLD SYSTEM
1.0mts		
1.5mts		
2.0mts		
2.5mts		
3.0mts		

Note: All quoted prices include all the relevant components and, for the purposes of this price guide, have been calculated using the ceiling fix brackets. Wall fix brackets and batons quoted for separately. All tracks quoted are finished in white.

Bracket Options

PRODUCT CODE	PRODUCT DESCRIPTION	PER BOX	UNIT PRICE
780007	Ceiling Bracket White	100	
780008	Smart Klick Ceiling Bracket	100	
780009	Smart Klick Double Ceiling Bracket White	30	
780010	Smart Klick Wall Bracket 35mm White	50	
780011	Smart Klick Wall Bracket 60mm White	50	
780012	Smart Klick Aluminium Bracket 75mm single	20	
780013	Smart Klick Aluminium Bracket 100mm single	20	
780014	Smart Klick Aluminium Bracket 150mm double	15	
781022	Smart Klick Adjustable Bracket White	25	

PRODUCT INFORMATION

- Heavy duty hand drawn system for medium and heavy draperies.
- Bendable; it can be curved and reverse curved using a 20cm radius or continuously curved.
- Heavy duty clickable carriers - 5 carriers on a breakaway strip - UV protected. Can also be used with ball bearing carriers.

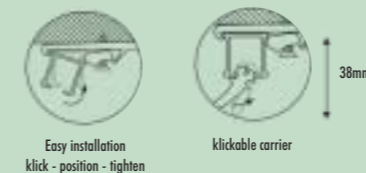

- Ideal for use with overlap masters and batons which can be mounted behind or in front of draperies.
- Can also be used for ripplefold.
- Maximum fabric weight: 8 kg. per metre.
- Track finish: chromated powder coating with a factory applied patented dry lubricant.
- Limited lifetime warranty.

BENDING/CURVING

The track can be curved and reverse curved using a 20cm radius. Continuous curving is also available by special order from factory only.

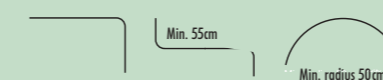

Bending instruction leaflet enclosed.

PROFILE

Weight: 235 gram per metre
Aluminium extrusion 6063 T5
Dimensions: 20mm x 20mm

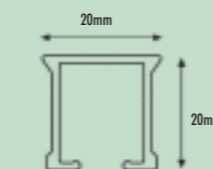

FOR USE IN

Hotels - motels - offices - schools - healthcare - residential or anywhere a heavy duty hand drawn system is required.

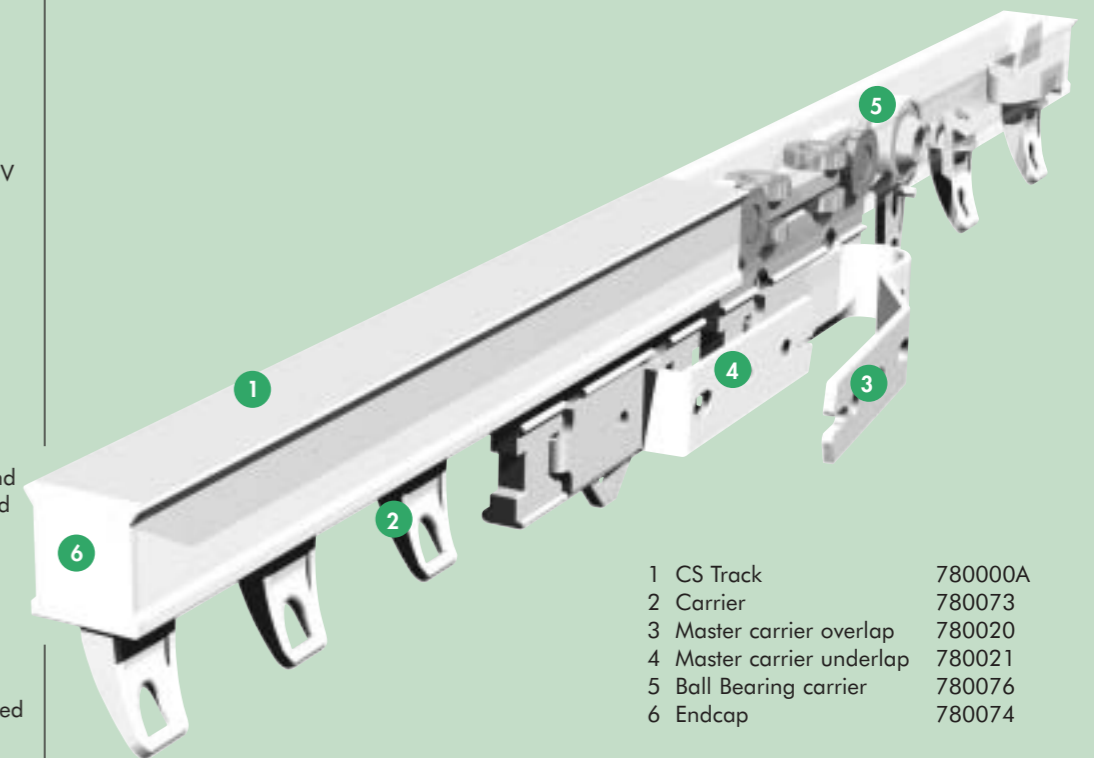

- | | |
|---------------------------|---------|
| 1 CS Track | 780000A |
| 2 Carrier | 780073 |
| 3 Master carrier overlap | 780020 |
| 4 Master carrier underlap | 780021 |
| 5 Ball Bearing carrier | 780076 |
| 6 Endcap | 780074 |

APPLICATIONS

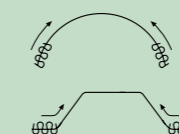
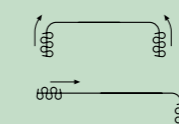
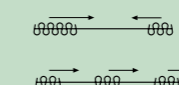
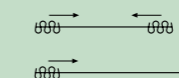

MOUNTING BRACKETS

SK Ceiling Bracket 780008

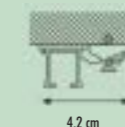

SK Wall bracket aluminium single 780012 A) 7.5cm : B) 6.3cm 780013 A) 10cm : B) 8.8cm

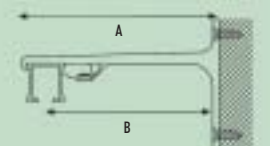

A) Min. 20cm



SK Wall bracket aluminium double 780014 A) 15cm : B) 9.2cm C) 4.5cm A) 20cm : B) 9.2cm C) 9.5cm

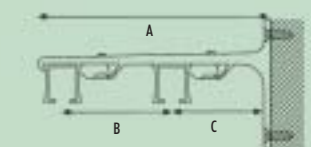

A) Min. 20cm



SK Wall bracket aluminium triple 25cm

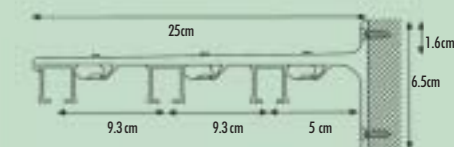

- Adjustable bracket available 781022
- Two brackets at each end 60cm apart and up to 95cm over remainder of track depending on weight of treatment.

